

The NEXUS Range of Conditioning Amplifiers Types 2690, 2691, 2692 and 2693

The NEXUS™ concept is based on flexibility. A single mainframe, a variety of input and output channels, and different filter options make the system highly customizable, as you can configure your conditioning amplifier to suit your needs. You can have acoustic and vibration inputs in the same mainframe with one, two, three or four independent input channels.

The NEXUS units you already own can also be reconfigured if your requirements change. For example, if you have a 1-channel charge conditioning amplifier, it can be upgraded to a 2-channel charge/2-channel microphone conditioning amplifier. In addition, a selection of optional filters can be installed in each channel module upon request.

Microprocessors are used for control, display and interfacing purposes, but the signal is analogue to obtain optimum signal/noise ratio and the lowest possible distortion. NEXUS supports transducers with transducer electronic data sheets (TEDS) according to IEEE 1451.4.



Uses And Features

Uses

- Specially suited for automotive use. Developed in association with major car manufacturers, for high-quality field and laboratory measurement systems
- For use with charge accelerometers, hydrophones, force transducers, condenser microphones, CCLD* accelerometers, CCLD preamplifiers, voltage input and sound intensity probes
- Field recording of vibration and acoustic signals
- Specially suitable for applications where shocks and impulses occur such as gas turbine testing and munitions testing (Types 2692-C and -D only)

* CCLD: Constant current line drive, also known as DeltaTron (IEPE compatible)

Features

- Highly flexible construction: 1-, 2-, 3- or 4-channel configurations that can be a combination of acoustic and/or vibration transducer inputs with different filter options
- High input signal range, low noise and extensive overload facilities
- Supports transducers with TEDS according to IEEE 1451.4
- Available for: charge, microphone, sound intensity, CCLD and very high input
- Compact robust design and battery operation makes it also suitable for use in the field
- Serial control interface (RS-232) allows for computer control of set-up and test functions. A large number of amplifiers can be controlled from a single PC
- High accuracy due to reliable construction and a wide range of calibration options. Patented Charge Injection Calibration (CIC) and the patented Mounted Resonance Test (MRT) are built-in
- Wide range of filters that can be set up for specific tasks
- Rack-mounting frames available

To survive the harsh electrical environment in cars, NEXUS conditioning amplifiers have specifications that far exceed the strict European EMC immunity requirements. ISO 7637-1 “Road Vehicles – Electrical disturbance by conduction and coupling” requirements are met. Mechanical robustness is equally high and meets MIL–STD–810C and IEC 60068–2–6 standards.

Environmental

Since all NEXUS amplifiers are built for portable outdoor use, they meet strict requirements for temperature and humidity. The operating temperature range extends from –10 to +55 °C (14 to 131 °F). The instrument will withstand rain if kept with the front panel facing upwards. However, because of the sockets on the back panel it is not watertight.

Modular Flexibility

All NEXUS conditioning amplifiers use the same mainframe and power supply hardware, while the channel configuration is based on interchangeable modules. This modular design gives the amplifiers a high degree of flexibility with regards to design. To reduce the cost of the instrument and to ensure accuracy and reliability, modules must be replaced at Brüel & Kjær.

Fig. 1
Modular design of NEXUS conditioning amplifiers

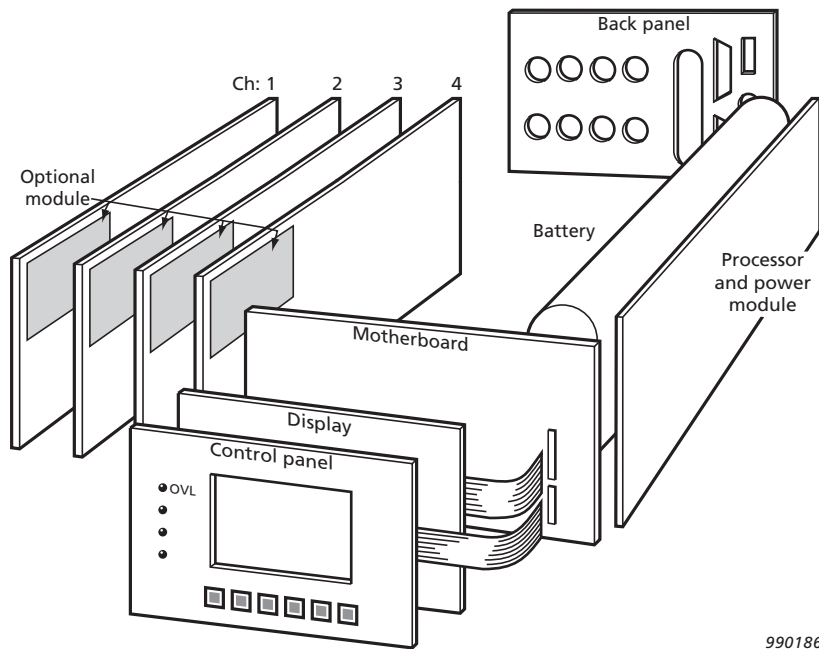

990186

Standard Versions

A number of standard versions are available that cover the most commonly used configurations. However, if you require a combination not found below, we can provide a custom-made version.

NEXUS Standard Version	Type/Order Number
2-channel Microphone Conditioning Amplifier with A, B, C and D Filters	2690-A-0F2
4-channel Microphone Conditioning Amplifier with A, B, C and D Filters	2690-A-0F4
1-channel Microphone Conditioning Amplifier	2690-A-0S1
2-channel Microphone Conditioning Amplifier	2690-A-0S2
4-channel Microphone Conditioning Amplifier	2690-A-0S4
2-channel (Single Probe) Intensity Conditioning Amplifier	2691-A-0S2
1-channel Charge Conditioning Amplifier with Single and Double Integration	2692-A-0I1
2-channel Charge Conditioning Amplifier with Single and Double Integration	2692-A-0I2
4-channel Charge Conditioning Amplifier with Single and Double Integration	2692-A-0I4
1-channel Charge Conditioning Amplifier with Constant Power On	2692-A-0P1
1-channel Charge Conditioning Amplifier	2692-A-0S1
2-channel Charge Conditioning Amplifier	2692-A-0S2
3-channel Charge Conditioning Amplifier	2692-A-0S3
4-channel Charge Conditioning Amplifier	2692-A-0S4
4-channel NEXUS Conditioning Amplifier for Very High Levels (100 nC)	2692-C*
4-channel NEXUS Conditioning Amplifier for Very High Levels (100 nC) with Integration Filters	2692-D*
1-channel CCLD Conditioning Amplifier with Integration Filter	2693-A-0I1
4-channel CCLD Conditioning Amplifier with A, B, C and D Filters	2693-A-0F4
4-channel CCLD Conditioning Amplifier with Single and Double Integration	2693-A-0I4
4-channel, 2-channel Charge and 2-channel CCLD Conditioning Amplifier	2693-A-0M4
4-channel CCLD Conditioning Amplifier with Constant Power On	2693-A-0P4
1-channel CCLD Conditioning Amplifier	2693-A-0S1
2-channel CCLD Conditioning Amplifier	2693-A-0S2
4-channel CCLD Conditioning Amplifiers	2693-A-0S4
NEXUS Accessories	Type/Order Number
Upper Limiting Frequency 140 kHz	WH-3219
Constant Power On	WH-3345
Single and Double Integration Filter	ZE-0788
A, B, C and D Weighting Filters	ZE-0794
Individual filters available on request	

* See separate Product Data (BP 1976)

Custom-made Versions

If you need a number and/or combination of channels not found in a standard version, each conditioning amplifier has up to four separate channels for charge, microphone and CCLD inputs or up to two separate channels for intensity inputs since sound intensity probes require two channels. Furthermore, any combination of the different channel types is possible. If you want to change the configuration of your NEXUS amplifier, it must be returned to Brüel & Kjær for updating and calibration.

A conditioning amplifier can contain up to four modular channels. Each channel consists of a common module, an input module, an optional module and an output module. The common module contains filters, gain settings and calibration functions. The input and output modules have additional gain settings and include high-pass filters.

Fig. 2
Back panel of a 4-channel NEXUS Conditioning Amplifier Type 2690-A-OS4. Each input module has a 7-pin LEMO connector for connecting Brüel & Kjær's Falcon™ range microphones and a BNC output channel

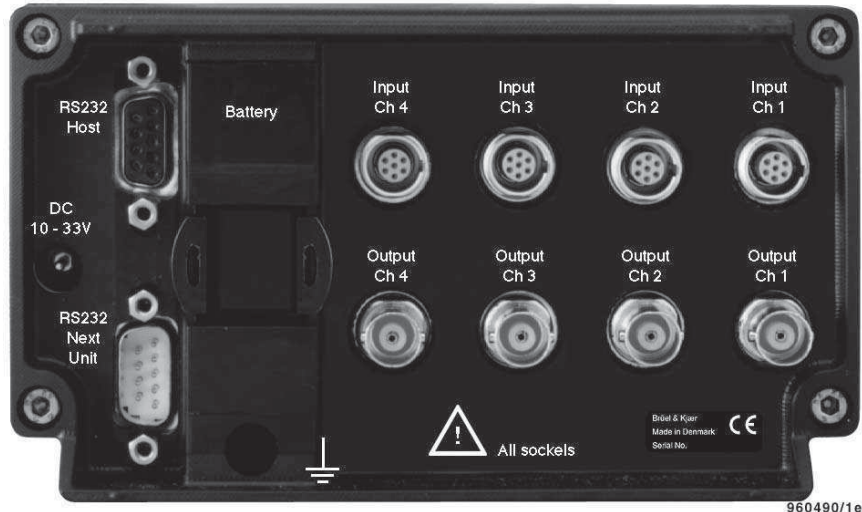

Charge Channel

A conditioning amplifier can contain up to four separate charge input channels. Each channel has comprehensive high- and low-pass filtering facilities. TNC input connectors are used and TNC to 10–32 UNF adaptors are provided. Input can be single ended or floating.

Single and double integration modes are available in some standard versions and also as an option for all input modules.

Use the built-in MRT to get information about the mounting of the associated charge accelerometer and general errors in the measurement setup.

Note: NEXUS Conditioning Amplifier Types 2692-C and 2692-D are designed for applications where very high charge inputs (up to 100 nC) can occur, see Product Data [BP 1976](#) for more information

Microphone Channel

You can have up to four microphone channels in a single conditioning amplifier.

7-pin LEMO sockets are used to connect Falcon range microphone preamplifiers. Floating inputs are used for maximum electromagnetic interference protection. The microphone polarization voltage can be set to 0 or 200 V, and the short-circuit protected microphone preamplifier supply voltage can be set to ± 40 or ± 14 V. In addition to the extensive low-pass filters, there is a 20 Hz high-pass filter that is useful for suppressing wind noise. An A-weighting type 0 filter is standard.

One of the comprehensive overload facilities is current overload detection. It is used to determine excessive drive current for the microphone preamplifier, thereby indicating an overload that may be very difficult to detect, especially in a setup with long cables and high-frequency signal content.

The patented CIC technique is also implemented, and will reveal setup errors such as incorrect/missing polarization voltage and leakage in the microphone.

Sound Intensity Channel

One or two sound intensity probes can be connected with 7-pin LEMO connectors in a single conditioning amplifier containing two or four intensity channels.

The features of the sound intensity channel are very similar to the microphone channel, but it has IEC 61043 standard Class 1 and ANSI S1.9–1996 Class 1 phase- and gain-match specifications using the special intensity 20 Hz high-pass filter.

CCLD Channel

Up to four CCLD input modules can be fitted for conditioning of input signals from CCLD based accelerometers, microphone preamplifiers or direct voltage input.

The input BNT socket can be floating or single-ended. A constant current of 4 or 10 mA is supplied in the CCLD mode. It also supplies an 8 V DC voltage on the inner screen of the TNC socket for connecting a tacho probe.

The current overload detection circuit, similar to the one used for microphone input modules, has been implemented.

Reference and Test Generators

A reference generator is available with all channel types and can be used as an excitation signal for your measurement setup. The output signal is a sinusoidal signal with 1 V RMS level. For charge channels a test tone is also available. It is a 159.2 Hz ($\pm 1\%$) sinusoidal signal which is applied in parallel with the charge input signal.

Output Module

For all channels, the output module will drive 20 m of cable to 100 kHz, 100 m of cable (100 pF/m) to 20 kHz or 1000 m to 2 kHz. A BNC connector is used, and you can select single-ended or floating mode. The output is protected against short-circuits and voltage overload, even if instrument is switched off.

Flexible Filter Configuration

Built-in Filters

A number of filters are available as standard within NEXUS. The filters are low-pass filters with cut-off frequencies of 0.1, 1, 3, 10, 22.4, 30 and 100 kHz (40 dB/decade), high-pass filters with 0.1, 1, 10 and 20 Hz cut-off frequencies (10, 20 Hz/80 dB/decade), A-weighting for microphone/intensity channels and a 20 Hz/40 dB/decade intensity filter for intensity channels.

Optional Filters

In addition to the built-in filters, a number of optional standard filters can be installed upon request, for example A-, B-, C- and D-weighting and single/double integration. User-defined filters can be made on special request. Note that for embedded software versions greater than 1.2, there are no restrictions on the use of the optional filters in conjunction with the built-in standard high- and low-pass filters.

Fig. 3
 Typical amplitude characteristics for NEXUS high-pass and low-pass filters. Note that all low-pass filters were measured in conjunction with the 0.1 Hz high-pass filter

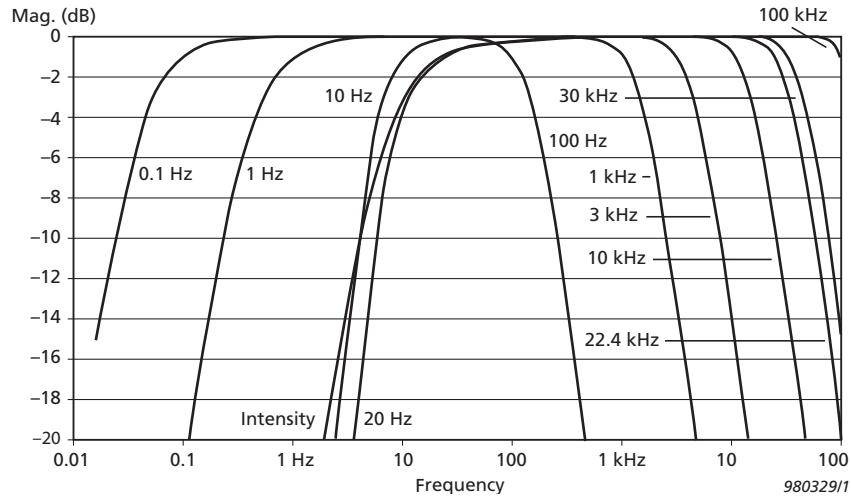

Fig. 4
 Typical phase characteristics for NEXUS high-pass and low-pass filters. Note that all low-pass filters were measured in conjunction with 0.1 Hz high-pass filter

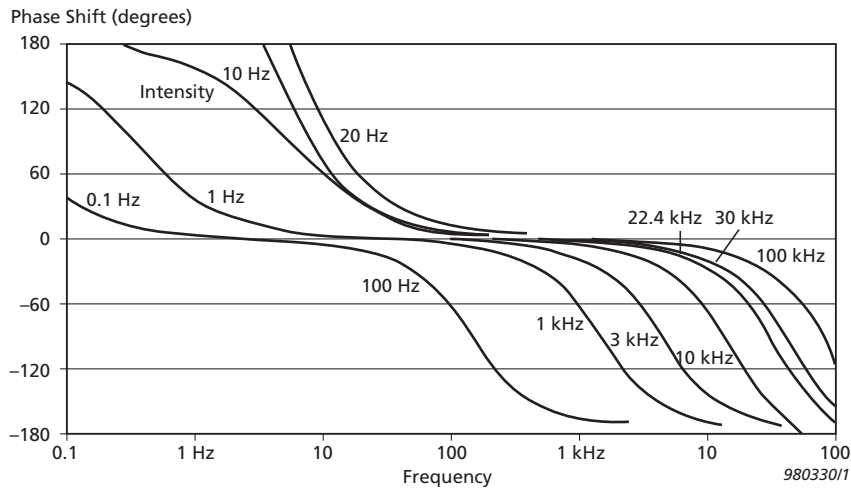

Fig. 5
 Typical amplitude characteristics for velocity and displacement filters (that is, single and double integration, respectively) with 1 Hz and 10 Hz cut-off frequencies

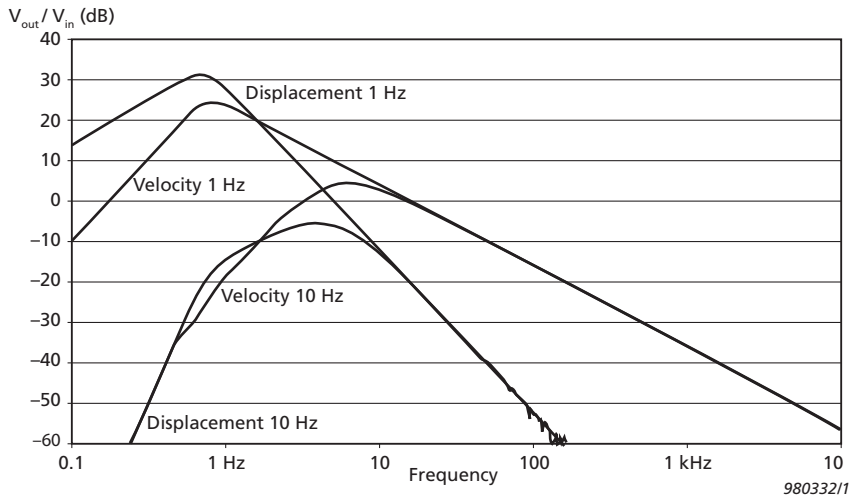
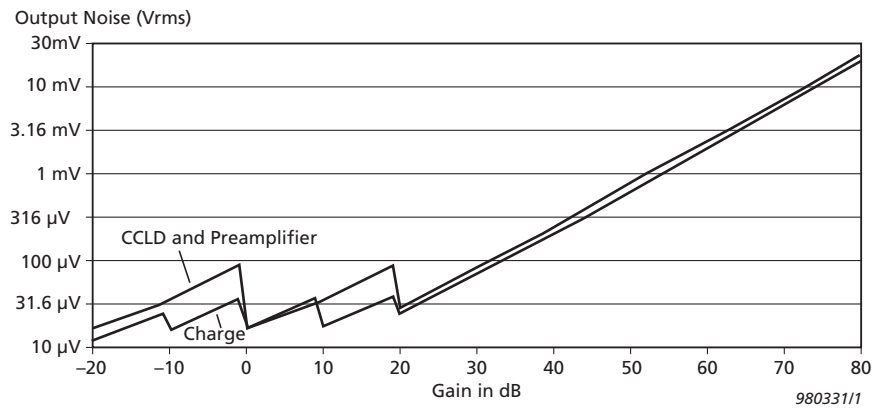

Fig. 6
 Typical broadband
 output noise
 measured in 22 kHz
 bandwidth as a
 function of NEXUS
 gain setting



Accuracy

An extremely accurate gain control is used in NEXUS amplifiers. For all gain steps and for each filter there is an automatic gain adjustment, the value of which has been stored during testing and calibration at Brüel & Kjær. This ensures that the gain step linearity is typically better than 0.02 dB.

Gain

The overall NEXUS gain is automatically calculated by the equation:

$$\text{Gain} = \text{Output Sensitivity} / \text{Transducer Sensitivity}$$

where Output Sensitivity and Transducer Sensitivity are set by the user.

If needed, it is possible to use an application correction factor (for example, if using an external attenuator). This will also be automatically calculated into the gain, using the equation:

$$\text{Gain} = \text{Output Sensitivity} / (\text{Transducer Sensitivity} \times \text{Application Correction Factor})$$

Computer Control

Serial RS–232 Interface

All functions can be controlled via the serial RS–232 interface. It is possible to switch the power on or off via the RS–232.

Controlling Several Amplifiers

You can “daisy-chain” up to 99 channels. Each unit can be automatically addressed from an optional PC program.

NEXUS Setup and Control Software Type 7749

Type 7749 is a PC-based software package for set-up and control of the NEXUS range of conditioning amplifiers. It is supplied with each instrument and automatically detects IEEE 1451.4 capable transducers with standardized TEDS.

Six pushkeys – nothing more is required to set up all parameters from the associated menus:

- Amplifier Setup: Set up filters and gain for each individual channel. Also displays information about battery capacity and overload condition
- Transducer Setup: Select transducer type and entering calibrated sensitivity
- Transducer Supply: Set up current supply, preamplifier/polarization voltages and cable length
- Floating/Correction: Select floating input/output and for entering application corrections
- Store/Recall Setup: Store/retrieve of five user-defined setups
- Display Setup: Switch back-lighting on/off and adjusting the display contrast
- Transducer Test/Ref. Sig.: Select test or reference signals and CIC and MRT parameters
- Battery Setup: Read out status on battery charge condition and number of charging cycles
- Serial Interface: Set up RS–232 parameters
- Self-test: Test the digital hardware

Intelligent Battery

Fig. 7
Battery Charger
UA-1590 is available
as an accessory



The rechargeable battery used in NEXUS amplifiers is an intelligent, nickel metal hydride battery. These batteries have built-in LEDs to inform you of the charge condition even if the battery is not mounted in the instrument (for example, to check a spare battery). The charge condition can also be seen on the display. In addition to large capacity, the batteries have the advantage of no “memory effect”, meaning you do not have to regularly discharge them and you can charge them from any starting charge condition.

Charging of the battery can be performed with the battery inside NEXUS; however, measurements cannot be made at the same time. The charging time is approximately four hours. The supplied mains adaptor or an external 14 to 33 V DC supply is required to charge the battery.

Overload Detection

All types of overload are indicated on the front panel LEDs. If you select the relevant menu you can get information about the type of overload on the display, or you can get the data via the RS-232 interface.

Comprehensive overload detection facilities are built into the conditioning amplifier: transducer current overload (CCLD and microphones), transducer voltage overload (CCLD), common mode input overload, signal overload and common mode output overload.

Peak Meter

A peak level meter allows you to monitor the instantaneous peak values for all channels and the maximum peak values (peak hold) since they were reset. Overload indications are also shown in this menu.

Charge Injection Calibration (CIC)

The patented Charge Injection Calibration technique makes it possible to remotely verify the condition of the entire measurement setup including the microphone. Available on microphone channels only.

Mounted Resonance Test (MRT)

This is another patented Brüel & Kjær technique used to get information about the accelerometer mounting and verify that the cable connections are in working order. A short voltage pulse is used to excite the transducer. The amplifier switches to a measurement mode, measures the resonance frequency and registers it on the display. MRT works with a number of Brüel & Kjær charge accelerometers that have a resonance frequency between 3 and 40 kHz. Available on charge channels only.

Support of Transducers with TEDS according to IEEE 1451.4

Fig. 8
Transducer setup. The sensitivity and mode fields have been automatically read from the IEEE 1451.4 compatible transducers



NEXUS units with embedded software version 2.0 or later can identify transducers with built-in TEDS that comply with the IEEE 1451.4 standard. Such transducers can be identified by their type numbers and their sensitivities read into the NEXUS unit.

Selected NEXUS Transducers and Accessories

Charge Input

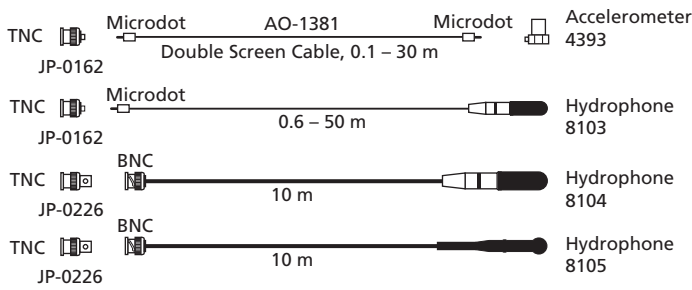

Microphone Input

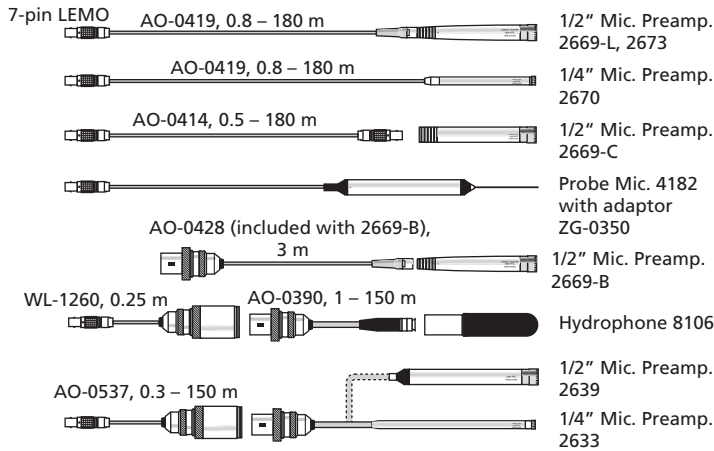

Intensity Input

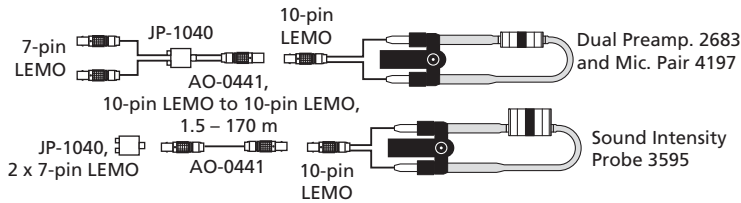

CCLD Input

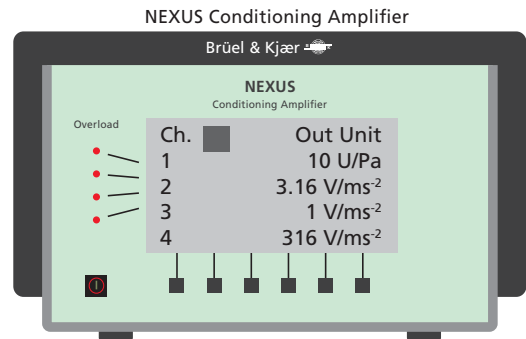
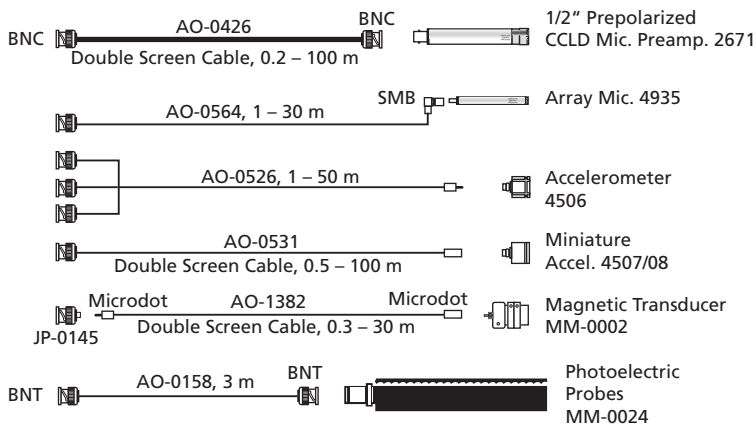

Powering

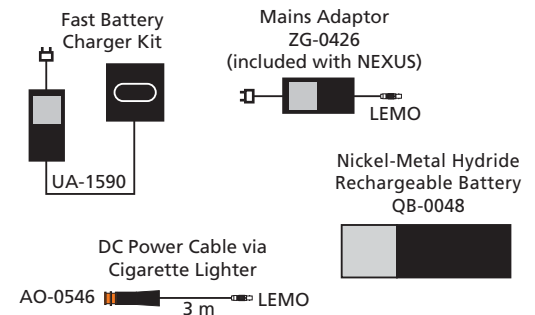





Adaptor



Software



Compliance with Standards

   	<p>The CE marking is the manufacturer's declaration that the product meets the requirements of the applicable EU directives</p> <p>RCM mark indicates compliance with applicable ACMA technical standards – that is, for telecommunications, radio communications, EMC and EME</p> <p>China RoHS mark indicates, that the Environment Friendly Use Period (EFUP) is 25 years according to the Ministry of Information Industries of the People's Republic of China</p> <p>WEEE mark indicates compliance with the EU WEEE Directive</p>
Safety	<p>EN/IEC 61010–1: Safety requirements for electrical equipment for measurement, control and laboratory use.</p> <p>ANSI/UL 61010–1: Safety requirements for electrical equipment for measurement, control and laboratory use</p>
EMC Emission	<p>EN/IEC 61000–6–3: Generic emission standard for residential, commercial and light industrial environments.</p> <p>EN/IEC 61000–6–4: Generic emission standard for industrial environments.</p> <p>EN/IEC 61326-1: Electrical equipment for measurement, control and laboratory use - EMC requirements</p> <p>CISPR 22: Radio disturbance characteristics of information technology equipment. Class B Limits.</p>
EMC Immunity	<p>EN/IEC61000–6–1: Generic standards – Immunity for residential, commercial and light industrial environments.</p> <p>EN/IEC 61000–6–2: Generic standards – Immunity for industrial environments.</p> <p>EN/IEC 61326-1: Electrical equipment for measurement, control and laboratory use - EMC requirements.</p> <p>ISO 7637 – 1, 7637 – 2 and 7637 – 3: Road Vehicles – Electrical Disturbance by Conduction and Coupling.</p> <p>Note 1: Refer to “Environmental Susceptibility” in specifications.</p> <p>Note 2: The above is guaranteed using the accessories in this Product Data only.</p>
Temperature	<p>IEC 60068–2–1 & IEC 60068–2–2: Environmental Testing. Cold and Dry Heat.</p> <p>Operating Temperature: –10 to +55 °C (14 to 131 °F)</p> <p>Storage Temperature: –25 to +70 °C (–13 to +158 °F)</p> <p>IEC 60068 – 2 – 14: Change of Temperature: –10 to + 55 °C (2 cycles, 1 °C/min.)</p>
Humidity	<p>IEC 60068–2–78: Damp Heat: 90% RH (non-condensing at 40 °C (104 °F))</p>
Mechanical	<p>Operating (peak values):</p> <p>MIL–STD – 810C: Vibration: 12.7 mm, 15 m/s², 5 – 500 Hz</p> <p>Non-operating:</p> <p>IEC 60068–2–6: Vibration: 0.3 mm, 20 m/s², 10 – 500 Hz</p> <p>IEC 60068–2–27: Shock: 1000 m/s²</p> <p>IEC 60068–2–29: Bump: 1000 bumps at 250 m/s²</p>
Enclosure	<p>IEC 60529: Protection provided by enclosures: IP 43</p>

Input Specifications – NEXUS Conditioning Amplifier Types 2690 to 2693

For Specifications on Types 2692-C and 2692-D, see Product Data [BP 1976](#).

Charge Input

Connector: TNC

Grounding: Single-ended or floating

MAXIMUM INPUT

Differential Charge: 10 nC (peak)

Common Mode Voltage: 4.2 V (peak)

At gain ≥ 0.316 mV/pC (-10 dB gain with 1 nF transducer capacitance)

INPUT PROTECTION

Differential Charge: ≤ 300 nC (peak)

Common Mode Voltage: ≤ 15 V (peak)

COMMON MODE REJECTION RATIO

>50 dB (typical) (50 to 60 Hz with 1 nF transducer capacitance)

AMPLIFIER GAIN

0.1 mV/pC to 10 V/pC (-20 to $+80$ dB gain with 1 nF transducer capacity, $+80$ dB only recommended with 10 Hz LP-filter selected)

TRANSDUCER SENSITIVITY RANGE

10^{-19} to 10^{-6} C/MU

(MU = mechanical units: m/s^2 , g , N, Pa)

CALIBRATED OUTPUT

Selectable in 10 dB steps. 100 dB attenuator range, 10^{-13} to 10^7 V/MU $\pm 1\%$ for $0^\circ\text{C} \leq T_a \leq +40^\circ\text{C}$ and $\pm 2\%$ for $-10^\circ\text{C} \leq T_a \leq +55^\circ\text{C}$

Frequency range from $5 \times f_l$ to $0.2 \times f_u$, where

f_l = lower freq. limit: 0.1, 1.0 or 10 Hz and

f_u = upper freq. limit: 0.1, 1, 3, 10, 30 or 100 kHz

FREQUENCY RANGE (-10%)

Acceleration: 0.1 Hz to 100 kHz (transducer cable length < 10 m)

Velocity (optional): 1.0 Hz to 10 kHz

Displacement (optional): 1.0 Hz to 1 kHz

LOW-PASS FILTER (-10%)

0.1, 1, 3, 10, 22.4, 30 or 100 kHz, attenuation slope 40 dB/decade

HIGH-PASS FILTER (-10%)

Acceleration: 0.1, 1.0 or 10 Hz

Velocity (optional): 1.0 or 10 Hz

Displacement (optional): 1.0 or 10 Hz

INHERENT NOISE (2 Hz to 22.4 kHz)

< 5 fC referred to input, $-10^\circ\text{C} \leq T_a \leq +40^\circ\text{C}$

< 10 fC referred to input, $40^\circ\text{C} \leq T_a \leq +55^\circ\text{C}$

(amplifier sensitivity > 20 dB) with 1 nF transducer capacitance)

HARMONIC DISTORTION AND NOISE

(2 Hz to 22.4 kHz, $Q_{in} \leq 2$ nC peak, $V_{out} \leq 3.16$ V peak)

$< 0.01\%$ for amplifier gain ≤ 0.1 V/pC

(< 40 dB gain with 1 nF transducer capacitance)

ENVIRONMENTAL SUSCEPTIBILITY (referred to input)

Magnetic Field: < 0.2 fC/(A/m)

Electromagnetic Field: < 20 fC/(V/m) or < 4 fC/V

Vibration (10 to 500 Hz): < 30 fC/(m/s^2)

MOUNTED RESONANCE TESTING (MRT)*

Mounted resonance testing of the accelerometer and cable

interconnection, controllable from front panel and

RS-232 interface

TEST TONE OSCILLATOR

$\omega = 1000$ rad/s (159.2 Hz), sinusoidal

Test Level: 1 mV to 10 V ($\pm 1\%$). Controllable from front panel and RS-232 interface

Reference Tone: 1 V (RMS), ($\pm 1\%$), 159.2 Hz

RISE TIME

> 7.5 V/ μs (100 kHz bandwidth)

CHANNEL TO CHANNEL PHASE-MATCH

(Between equal channels in the same NEXUS unit)

$2.1^\circ - 0.1^\circ \times (f/f_l)$ from f_l to $20 \times f_l$

0.1° from $20 \times f_l$ to $0.1 \times f_u$

$(f/f_u)^\circ$ from $0.1 \times f_u$ to f_u , where

f_l = lower freq. limit: 10 Hz and

f_u = upper freq. limit: 0.1, 1, 3, 10, 30 or 100 kHz

OPTIONAL FILTERS

Integration: Single and double

* Brüel & Kjær patent: EP Patent 715.722, US Patent 5.753.793

Microphone Input

Connector: 7-pin LEMO

Grounding: Outer shield grounded to chassis

INPUT IMPEDANCE

1 M Ω || 300 pF (AC coupled)

Max. Input: 31.6 V (peak)

Input Protection: ≤ 50 V (peak)

AMPLIFIER GAIN

-20 to +60 dB (+80 dB only recommended with 10 Hz LP-filter selected)

TRANSDUCER SENSITIVITY RANGE

10^{-12} to 10^3 V/MU

(MU = mechanical units: Pa, mm)

CALIBRATED OUTPUT

Selectable in 10 dB steps. 100 dB attenuator range, 10^{-13} to 10^7 V/MU

(± 0.1 dB for $0^\circ\text{C} \leq T_a \leq +40^\circ\text{C}$ and ± 0.2 dB for $-10^\circ\text{C} \leq T_a \leq +55^\circ\text{C}$)

Frequency range from $5 \times f_l$ to $0.2 \times f_u$, where

f_l = lower freq. limit: 0.1 or 20 Hz and

f_u = upper freq. limit: 0.1, 1, 3, 10, 22.4, 30 or 100 kHz

POLARIZATION VOLTAGE (± 0.5 V or $\pm 0.25\%$)

0 or 200 V (all channels simultaneously selected, short-circuit protected)

PREAMPLIFIER SUPPLY

Fixed ± 14 V, ± 40 V or controlled automatically in accordance with input range (short-circuit protected)

Max. current 45 mA (sum of all channels)

FREQUENCY RANGE (-1 DB)

0.1 Hz to 100 kHz (gain ≤ 60 dB) (complies with IEC 1260 Class 0 and ANSI S1.11 Type 0-AA for $f_l = 0.1$ Hz and $f_u = 100$ kHz)

HIGH-PASS FILTER (-1 dB)

0.1 Hz, attenuation slope 40 dB/decade or

20 Hz, attenuation slope 80 dB/decade

LOW-PASS FILTER (-1 dB):

0.1, 1, 3, 10, 22.4, 30 or 100 kHz, attenuation slope 40 dB/decade

A-WEIGHTING FILTER

Complies with IEC 61672-1

INHERENT NOISE (referred to input, gain >20 dB)

<2 μ V, A-weighted

HARMONIC DISTORTION AND NOISE

(2 Hz to 22.4 kHz, $V_{in} \leq 20$ V peak, $V_{out} \leq 3.16$ V peak)

<0.01% for amplifier gain ≤ 40 dB

ENVIRONMENTAL SUSCEPTIBILITY (referred to input)

Magnetic Field: <0.2 μ V/(A/m)

Electromagnetic Field: <10 μ V/(V/m) or <10 μ V/V

Vibration (10 to 500 Hz): <2 μ V/(m/s²)

CHARGE INJECTION CALIBRATION (CIC)*

Verification of the entire measurement set-up including the microphone, preamplifier and connecting cable. Controllable from front panel and RS-232 interface

Reference Tone: 1 V (RMS) $\pm 1\%$, 1 kHz

OVERLOAD DETECTION

Microphone preamplifier overload detection with respect to cable length (3 to 1000 meter)

RISE TIME

>7.5 V/ μ s (100 kHz bandwidth)

CHANNEL TO CHANNEL PHASE-MATCH

(Between equal channels in in the same NEXUS unit)

$5.1^\circ - 0.1^\circ \times (f/f_l)$ from f_l to $50 \times f_l$ ($f_l = 0.1$ Hz)

$2.1^\circ - 0.1^\circ \times (f/f_l)$ from f_l to $20 \times f_l$ ($f_l = 20$ Hz)

0.1° from $50 \times f_l$ to $0.1 \times f_u$ ($f_l = 0.1$ Hz)

0.1° from $20 \times f_l$ to $0.1 \times f_u$ ($f_l = 20$ Hz)

$(f/f_u)^\circ$ from $0.1 \times f_u$ to f_u , where

f_u = upper frequency limit: 0.1, 1, 3, 10, 22.4, 30 or 100 kHz

OPTIONAL FILTERS

A-, B-, C- and D-weighting (one module) Complies with IEC 61672-1

Intensity Input

Specifications as for microphone input, except when using the intensity filter

CONNECTOR

7-pin LEMO (two connectors on two input modules – adaptor required)

CHANNEL TO CHANNEL PHASE-MATCH AND FREQUENCY RESPONSE

(with intensity filter (20 Hz HP/22.4 kHz LP, 40 dB/decade))

Complies with IEC 61043 standard Class 1 and ANSI S1.9-1996 Class 1, with Brüel & Kjær sound intensity probes

Conditions: output sensitivity for the two channels must be equal and transducer sensitivity must be equal (within 0.5 dB)

CCLD Input

Connector: BNC, BNT

Grounding: Single-ended or floating

INPUT IMPEDANCE

1 M Ω || 100 pF (AC coupled)

MAX INPUT

Differential Voltage: ≤ 31.6 V (peak)

Common Mode Voltage: 4.2 V (peak)

INPUT PROTECTION

Differential Voltage: ≤ 50 V (peak)

Common Mode Voltage: ≤ 15 V (peak)

COMMON MODE REJECTION RATIO

50 dB (50 to 60 Hz) (typical)

AMPLIFIER GAIN

-20 to $+60$ dB gain ($+80$ dB only recommended with 10 Hz LP-filter selected)

TRANSDUCER SENSITIVITY RANGE

10^{-12} to 10^3 V/MU

(MU = mechanical units: m/s², m/s, g, N, lb, Pa)

CALIBRATED OUTPUT

Selectable in 10 dB steps. 100 dB attenuator range, 10^{-13} to 10^7 V/MU.

(± 0.1 dB for $0^\circ\text{C} \leq T_a \leq +40^\circ\text{C}$ and ± 0.2 dB for $-10^\circ\text{C} \leq T_a \leq +55^\circ\text{C}$)

Frequency range from $5 \times f_l$ to $0.2 \times f_u$, where

f_l = lower frequency limit: 0.1, 1.0 or 10 Hz and

f_u = upper frequency limit: 0.1, 1, 3, 10, 22.4, 30 or 100 kHz)

CONSTANT CURRENT SUPPLY ($\pm 15\%$)

+4 mA or +10 mA with a +28 V voltage source

TACHO PROBE SUPPLY

+8 V DC at BNT inner shield (short-circuit protected)

FREQUENCY RANGE (-10%)

0.1 Hz to 100 kHz (gain < 60 dB)

attenuation slope 40 dB

HIGH-PASS FILTER (-10%)

0.1 Hz or 1.0 Hz (with attenuation slope 40 dB) or 10 Hz (with attenuation slope 60 dB/decade)

LOW-PASS FILTER (-10%)

0.1, 1, 3, 10, 22.4, 30 or 100 kHz

INHERENT NOISE (referred to input, gain > 20 dB)

< 2.4 μV A-weighted

< 3.3 μV lin. 2 Hz to 22.4 kHz

HARMONIC DISTORTION AND NOISE

(2 Hz to 22.4 kHz, $V_{in} \leq 20$ V peak, $V_{out} \leq 3.16$ V peak)

$< 0.01\%$ for amplifier gain ≤ 40 dB

RISE TIME

> 7.5 V/ μs (100 kHz bandwidth)

ENVIRONMENTAL SUSCEPTIBILITY (referred to input)

Magnetic Field: < 0.2 $\mu\text{V}/(\text{A}/\text{m})$

Electromagnetic Field: < 3 $\mu\text{V}/(\text{V}/\text{m})$ or < 3 $\mu\text{V}/\text{V}$

Vibration (10 to 500 Hz): < 2 $\mu\text{V}/(\text{m}/\text{s}^2)$

OVERLOAD DETECTION

Preamplifier overload detection with respect to cable length (3 to 1000 meter)

CHANNEL TO CHANNEL PHASE-MATCH

(Between equal channels in the same NEXUS unit)

$5.1^\circ - 0.1^\circ \times (f/f_l)$ from f_l to $50 \times f_l$ ($f_l = 0.1$ or 1 Hz)

$2.1^\circ - 0.1^\circ \times (f/f_l)$ from f_l to $20 \times f_l$ ($f_l = 10$ Hz)

0.1° from $50 \times f_l$ to $0.1 \times f_u$ for $f_l = 0.1, 1$ Hz

0.1° from $20 \times f_l$ to $0.1 \times f_u$ for $f_l = 10$ Hz

$(f/f_u)^\circ$ from $0.1 \times f_u$ to f_u , where

f_u : upper freq. limit: 1, 3, 10, 22.4, 30 or 100 kHz

Reference Tone: 1 V (RMS) $\pm 1\%$ (0.1 dB), 1 kHz

OPTIONAL FILTERS

A-, B-, C- and D-weighting (one module). Complies with IEC 61672-1

Integration: single and double (one module). Other filters available upon request

Power Supply

INTERNAL BATTERY (not included)

Nickel metal hydride rechargeable battery supporting SMBus and featuring an on-battery charge-level meter. Typically provides 15 hours of continuous use with a single channel and 4 hours with four channels without backlighting and optional filters. With backlighting and optional filters, the battery typically provides 3 hours of continuous use. If NEXUS is not used for more than a month, please remove the battery to prevent discharging. Charging time is approximately 4 hours

EXTERNAL DC POWER INPUT

Complies with ISO 7637-1 (12 V) and 7637-2 (24 V)

Input Range: 10 to 33 V DC

MAINS SUPPLY

Supported via supplied Mains Adaptor ZG-0426 (included), 90–264 V AC, 40–65 Hz

Digital Control Interface

SERIAL INTERFACE

Conforms to EIA/TIA-574 (RS-232)

Baud rate: 2400, 4800, 9600

Parity: None

Data Bits: 8

Stop Bits: 1

Handshake: X-on/X-off

“Plug and play” interface coupling

Communication speed for a baud rate of 9600:

- Transmission time for one command of 5 characters is ~ 4 ms
- Transmission time for one command of 5 characters and to receive an echo after each character is ~ 8 ms
- Execution time for one command is 100 ms to several seconds
- Time to configure a complete 4-channel NEXUS using short form set-up with approx. 600 characters requires transmission time of 2 to 3 s (4 to 6 s with echo after each character)
- Execution time in NEXUS is from 40 to 60 s
- For setups with over 1000 characters, the transmission time will be increased by at least 30 s due to a delay in emptying receiver buffer
- Response time after requesting a status of one load: <0.5 s
- Response time after requesting a peak meter reading: <0.5 s

Display Interface

DISPLAY

64 × 128 pixel graphical display with back-lighting on/off

OVERLOAD DETECTION

On both common-mode and differential signals applied before filters. LED overload indication at the front panel and overload indication via RS-232 control interface

Peak Meter

Dynamic Range: –30 to +10 dBV (peak)

Resolution: 1 dB

Analogue Output

Connector: BNC

Grounding: Single-ended or floating

Output Impedance: 50 Ω || 500 pF

MAXIMUM OUTPUT (DIFFERENTIAL VOLTAGE)

3.16 V peak (6.32 V peak to peak)

MAXIMUM DC OFFSET

±25 mV, typically <2 mV

OUTPUT PROTECTION

Differential Voltage: ≤50 V (peak)

Common Mode Voltage: ≤15 V (peak)

Common Mode Rejection:

>50 dB (50 to 60 Hz) for common mode voltage ≤2 V peak (voltage injected into instrument)

OUTPUT DRIVE CAPACITY

100 m of cable length (100 pF/m) to 20 kHz

1000 m of cable length (100 pF/m) to 2 kHz

CHANNEL SEPARATION

better than –100 dB at 1 kHz

Dimensions and Weight

Height: 90 mm (3.5")

Width: 144 mm (5.7")

Depth: 230 mm (9.1")

Weight: Approx. 3 kg (6.6 lb), for a 4-channel unit including battery

Note: All values are typical at 25 °C (77 °F), unless measurement uncertainty is specified. All uncertainty values are specified at 2σ (that is, expanded uncertainty using a coverage factor of 2)

CALIBRATION

NEXUS amplifiers are supplied with a Manufacturer’s Certificate of Conformance. An initial calibration can be supplied as an option.

Type	Initial Calibration	Recalibration
2690-A	2690-A-CAI	2690-A-CAF
2691-A	2691-A-CAI	2691-A-CAF
2692-A	2692-A-CAI	2692-A-CAF
2693-A	2693-A-CAI	2693-A-CAF
2692-C	2692-A-CAI	2692-A-CAF

Ordering Information — Conditioning Amplifier Types 2690, 2691, 2692 and 2693

Types 2690–2693 Conditioning Amplifier

includes the following accessories:

- ZG-0426: Mains adaptor, 90 – 264 V AC
- LK-0013: Ferrite cable clamp
- Type 7749: CD-ROM for NEXUS Setup and Control Software
- AO-1440: RS-232 interface cable

OPTIONAL ACCESSORIES

AO-0537	7-pin Brüel & Kjær mic. plug to 7-pin LEMO adaptor cable, 0.3 to 150 m (1 to 150') for use with Types 2633 and 2639 only
AO-0546	Supply cable with cigarette lighter to LEMO connector, 3 m (10')
BZ-5294	TEDS editor
BZ-5294-MS4	TEDS calibration license
BZ-5294-MS5	TEDS developer's license
QB-0048	Nickel metal hydride rechargeable battery DR35
UA-1482	Rack shelf, holds one or two NEXUS units
UA-1590	Fast charger kit
UL-0250	Adaptor, RS-232 to USB
WA-0876	TEDS editor calibration kit
WA-0877	TEDS editor development kit
WH-3219	Upper-limiting frequency 140 kHz
WH-3345	Constant power on
WL-1218	Adaptor for 2 × 7-pin intensity probe, LEMO connectors to 18-pin LEMO connector
ZE-0794	A-, B-, C- and D-weighting filters
ZE-0788	Integration, single and double (contact Brüel & Kjær for a configured system)

Brüel & Kjær and all other trademarks, service marks, trade names, logos and product names are the property of Brüel & Kjær or a third-party company.

Brüel & Kjær Sound & Vibration Measurement A/S
DK-2850 Nærum · Denmark · Telephone: +45 77 41 20 00 · Fax: +45 45 80 14 05
www.bksv.com · info@bksv.com
Local representatives and service organizations worldwide

Although reasonable care has been taken to ensure the information in this document is accurate, nothing herein can be construed to imply representation or warranty as to its accuracy, currency or completeness, nor is it intended to form the basis of any contract. Content is subject to change without notice – contact Brüel & Kjær for the latest version of this document.

www.valuetronics.com

Brüel & Kjær 

